

BRISTAN

Installation Instructions and User Guide

Artisan Evo

Digital Electronic Mixer

Shower

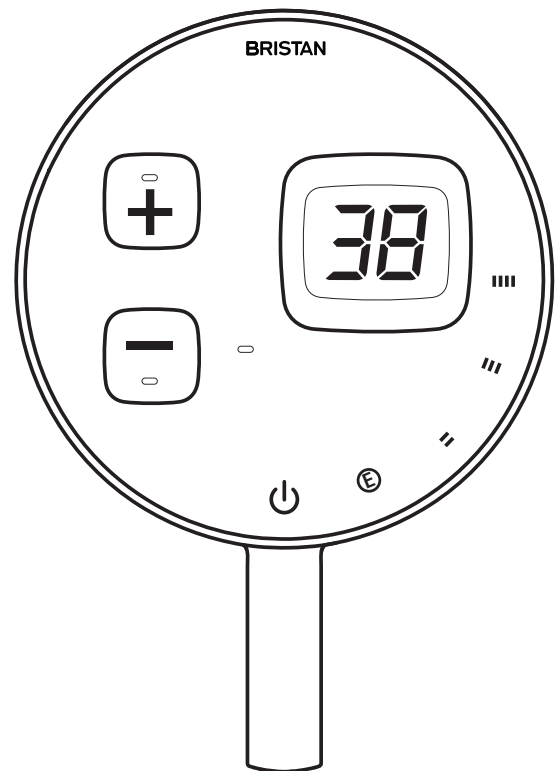

Models covered: ARDE SHCAR W &
ARDE SHCAR B

Please keep this booklet for future
reference.

Installer, when you have read these
instructions please ensure you leave
them with the user.

Contents

Welcome to your new Bristan Digital Electronic Mixer Shower, featuring a contemporary design, wireless electronic controller and digital mixing unit.

Bristan's Digital Electronic Mixer Shower has been designed to be easy to install and use. It has also been designed and tested in the UK to all of the relevant British Standards.

These instructions are for your guidance to a safe and successful installation, so please read them thoroughly and retain for future reference.

We recommend the installation is carried out by a suitably qualified person and must conform with current I.E.E Wiring Regulations (BS7671) and Building Regulations (Part P and Part G).

Important Safety Information	3
General Information	4
Pack Contents	5
Tools Required	5
Product Features	6
Specifications	7
Dimensions	8
Installation Requirements	9-11
Positioning the Mixer Valve	9
Water Requirements	10
Electrical Requirements	11
Installation	12-18
Fitting the Mixer Valve	12
Plumbing Connections	13
Electrical Connections	14
Fitting the Wireless Controller	15
Wall Outlet	16
Riser Kit	17-18
Commissioning	19-21
Wireless Initialisation & Pairing	19-20
Maximum Temperature Setting	20
Water / Plumbing Connections	21
Basic Functional Testing	21
Operating the Shower	22
Maintenance	23-25
Troubleshooting	26-27
Spare Parts	28-29
Guarantee	30-31

Important Safety Information

- Please read these instructions thoroughly and retain for future use.
- All products manufactured and supplied by Bristan are safe provided they are installed, used correctly and receive regular maintenance in accordance with these instructions.
- **If you are in any doubt about your ability to install this product safely you must employ the services of an experienced qualified plumber / electrically qualified person.**
- This Digital Electronic Mixer Shower needs to be installed in accordance with, and meet the requirements of the Water Supply (Water Fittings) Regulations 1999 and Scottish Byelaws 2004.
- Before starting any installation please consider the following:
 - Before drilling into walls, check that there are no hidden electrical wires, cables or water supply pipes. This can be checked with the aid of an electronic detector.
 - If power tools are used do not forget to:
 - Wear eye protection
 - Unplug equipment after use
- **⚠ Warning:** Before installing the new Digital Electronic Mixer Shower it is essential that you thoroughly flush through the pipework in order to remove any remaining swarf, solder, etc. Failure to carry out this procedure could cause problems or damage to the workings of the Mixing Valve.
- Do not operate the shower if the water stops flowing during use or if the water is leaking from the Mixing Valve itself. Turn off at the mains electrical supply and refer to the Troubleshooting section (see pages 26-27) or contact Bristan Customer Services on 0844 701 6273.
- Do not block the flow of water from the showerhead, by placing it (smothering it) on your hand or any other part of your body or foreign object.
- Do not crush or kink the shower hose, this could damage the hose and cause leaks.
- **⚠ Warning:** Do not operate this product if you suspect it is frozen. Do not site the Mixing Valve where it might be subjected to freezing conditions.



0359

BEAB (British Electrotechnical Approvals Board) approval of safety.











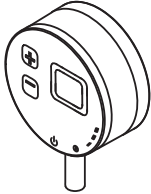

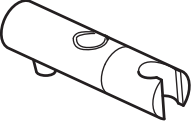

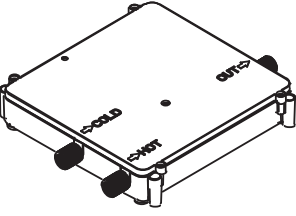

Hereby, Bristan Group Ltd, declares that this Electronic Mixing Valve with Wireless Controller is in compliance with the essential requirements and other relevant provisions of the Directive 1999/5/EC. The declaration of conformity may be consulted at www.bristan.com/dop.

General Information

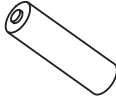

- Remove all packaging and check the contents for damage before starting any installation.
- Fitting isolation valves to the inlet feeds is required as close as is practical to the inlet connections for ease of maintenance.
- Always switch off the power at the consumer unit and isolate the electrical supply before making any electrical connections or if you have to remove the cover of the Mixing Valve.
- This product **must not** be modified in any way as this will invalidate the guarantee.

Recommended Usage			
Domestic	✓	Heavy Commercial	✗
Light Commercial	✓	Health Care	✗

Pack Contents & Tools Required

 Wireless Controller x1	 Remote Control Screw x3	 Slider / Handset Holder x1	 Riser Rail x1	 Wall Bracket x2
	 Mixing Valve Screw x4			
 Mixing Valve x1	 Riser Rail Screw x2	 Hose Retainer x1		 Wall Bracket end Cap x2
	 Wall Plugs x9	 Handset x1		 Riser Rail end Cap x2
 Wall Outlet x1	 Shower Hose x1		 Batteries x2	 Hose Washer x2

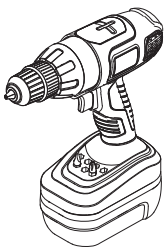
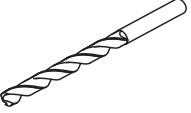
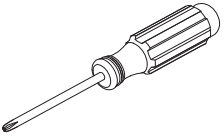
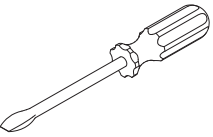
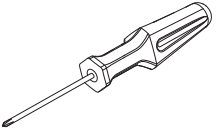
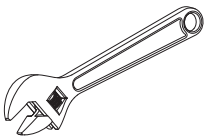
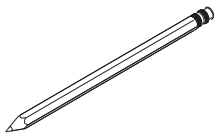
Tools Required - Not supplied

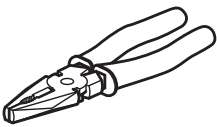
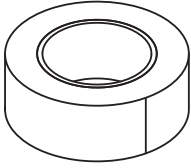
 Drill	 Suitable Drill bit	 Phillips Screwdriver	 Flat Screwdriver	 Electrical Screwdriver
 Spanner	 Pencil	 Electrical Tester	 Electrical Pliers	 Masking Tape

Product Features

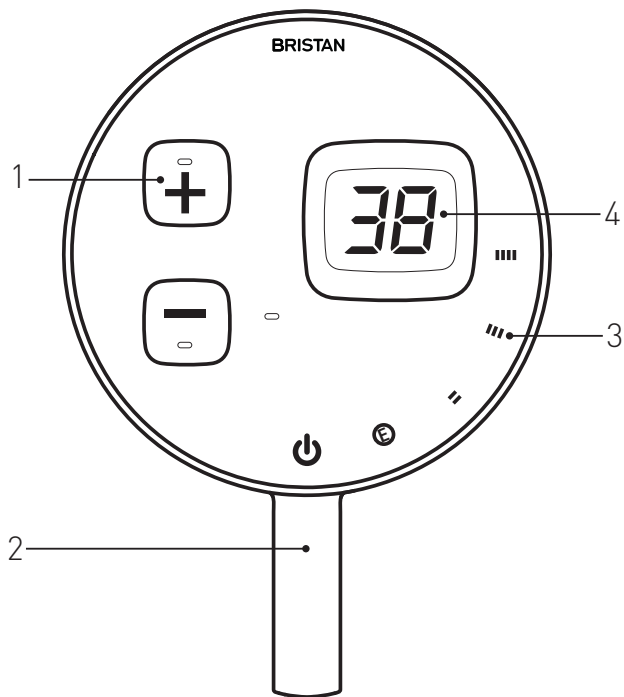

1. Temperature control

Press **+** to increase the temperature up to a factory set maximum of 48°C (the maximum temperature can be overridden, see Maximum Temperature Setting on page 20).

Press **-** to decrease the temperature down to a minimum of 35°C.

2. Lever handle

Turns the shower on and adjusts the flow of water. Turn anti-clockwise to turn the shower on and back to **⏻** to turn the shower off.

3. Water flow settings

The shower has 4 flow settings. Eco (**E**), Low (**III**), Medium (**IIII**), and High (**IIII**).

4. Digital display screen

Displays the water temperature **38**. Any error codes will be displayed on here.

Specifications

Water Supply Requirements

Inlet connections: 1/2" BSP with 69mm between centres.

Operating pressure range: Min. 0.5 bar - Max. 5.0 bar

For optimum performance a minimum dynamic working pressure of 1.0 bar is required.

Minimum static pressure: 0.5 bar

Maximum static pressure: 10.0 bar

Supply requirements:

Minimum cold water supply temperature: 5°C.

Maximum cold water supply temperature: 20°C.

Minimum hot water supply temperature: 52°C.

Maximum hot water supply temperature: 65°C.

Flow Performance

6 lpm - 12 lpm

(Dependant upon system capability)

Flow Setting	Flow Rate (lpm)
Ⓔ	6 lpm
▬▬	8 lpm
▬▬▬	10 lpm
▬▬▬▬	12 lpm

Electrical Supply Requirements

Supply voltage: 230V AC / 35W

Dimensions (mm)

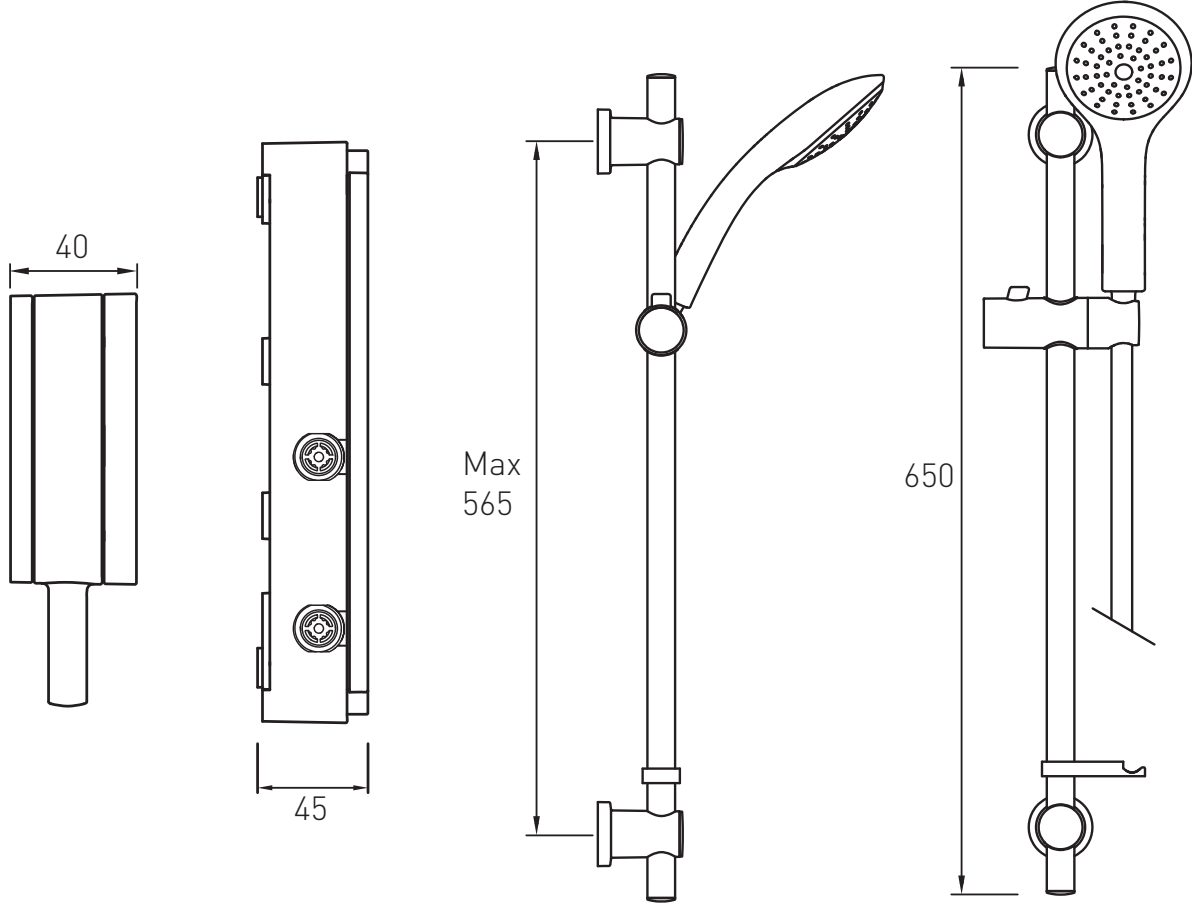
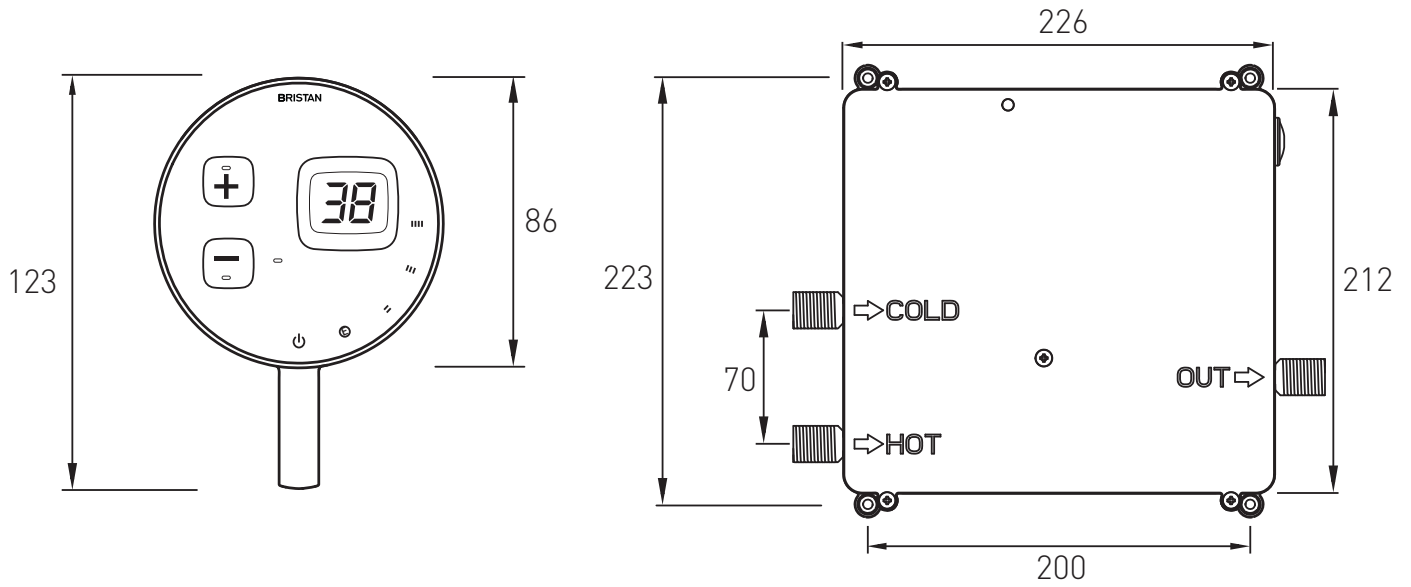

Installation Requirements

Positioning the mixing valve

The Mixing Valve can be positioned on either a wall surface or flat on the floor. (Refer to the diagrams for the correct orientation of the Mixing Valve).

The Mixing Valve can be installed in either an airing cupboard, loft space or under the bath. **Do not** site the Mixing Valve where it may be subjected to freezing conditions or ambient temperatures over 40°C.

The maximum distance from the Mixing Valve to the Wireless controller **must not** exceed 10 metres as this is beyond the operating range of the wireless controller. Metallic lined materials could significantly reduce the operating range or prevent operation.

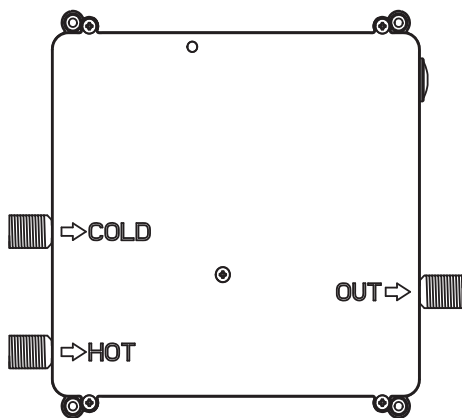

Flat on the floor or wall

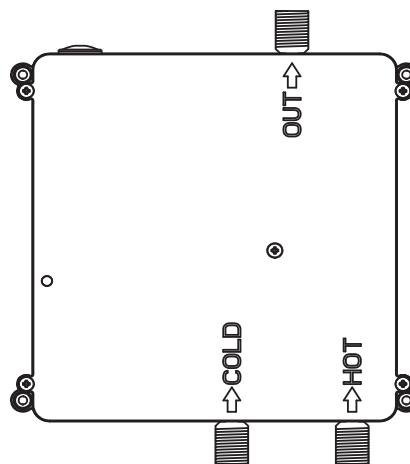

Facing up on the wall

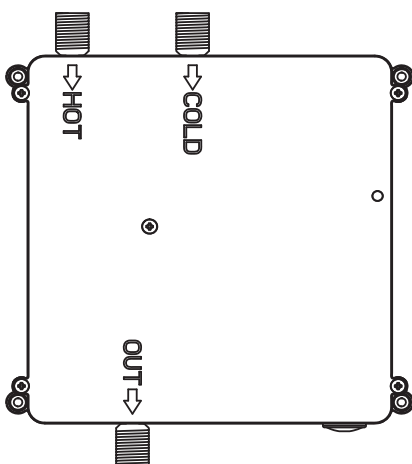

Facing down on the wall

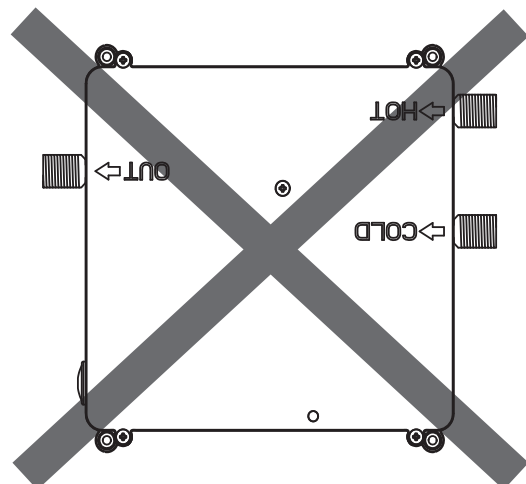

DO NOT INSTALL UPSIDE DOWN ON THE WALL!

Installation Requirements

Water Requirements

This fitting needs to be installed in accordance with the following Installation Requirements and Notes (IRN) to ensure they meet the requirements of the Water Supply (Water Fittings) Regulations 1999 and the Scottish Byelaws 2004.

The fitting shall be installed so that its outlet discharges above the spill-over level of any appliance as indicated on the illustration below.

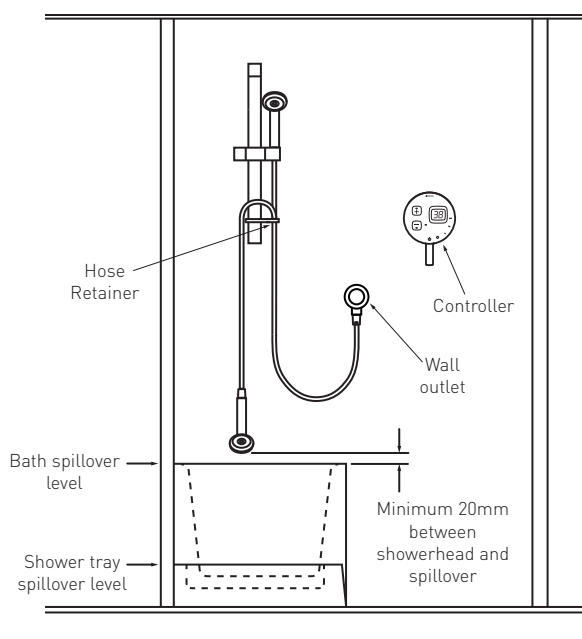

For backflow protection in premises or installations up to, and including Fluid Category 3 and 5.

The vertical distance of the outlet above the spill-over level shall be not less than 20mm or twice the diameter of the inlet pipe to the fitting, whichever is the

greater. If the fitting cannot be installed as indicated it shall be installed with a backflow prevention arrangement suitable for the Fluid Category.

If the shower is to be installed in a hard water area, we recommend that an in-line scale inhibitor is fitted which will prolong the life of the shower. Please refer to your supplier for advice.

⚠ Warning: the shower must not be installed in an area subject to freezing conditions. Do not use if you suspect the shower is frozen, this will damage the shower unit.

Maximum ambient temperature: 40°C.

A minimum working inlet pressure of 0.1MPa (1bar) at a minimum flow rate of 10 litres per minute is recommended for full performance.

The maximum static inlet pressure must not exceed 1.0MPa (10bar).

If it is intended to operate the shower above the recommended operating / dynamic pressure, a suitable pressure reducing valve (PRV) should be used.

Water regulations stipulate that a removable showerhead be constrained by a fixed or sliding attachment (hose retainer supplied) so that it can only discharge water at a point not less than 20mm above the spill-over level of the bath or shower tray or other fixed appliance.

Installation Requirements

Note: If a showerhead can sit within a bath, basin or shower tray, Water Regulations stipulate a double check valve must be fitted in the supply pipe work to prevent back siphonage*. If the showerhead can sit within a WC then the air gap should be a type AUK3 not less than 20mm or twice the diameter of the inlet pipe to the fitting, whichever is the greater.

* As this shower unit is already supplied with a single check valve pre-fitted in each water supply inlet, a further single check valve would be required in such a situation, fitted in each water supply as close as possible to the existing check valves.

Electrical Requirements

 **Warning: This appliance MUST be earthed!**

Power Rating: 230V AC / 35W

The Electrical Installation and Curcuit Protection of this shower must comply with current I.E.E Wiring Regulations (BS 7671) and Building Regulations (Part P). We recommend that this Digital Electronic Mixing Shower is installed by a qualified electrician prior to use. The following notes are for your guidance only.

Important: You **must** switch off the power at the consumer unit, isolate the electrical circuit and verify the earth before making any electrical connections.

The Mixing Valve must only be connected to a 230-240 V AC supply.

This product must be connected to a fused spur with double-pole isolation and a 3A fuse.

It is recommended that a residual current device (RCD) formerly known as an earth leakage circuit breaker (ELCB) with a tripping current of 30mA, incorporated in the circuit. This may be part of the existing consumer unit or a seprate unit.

For close circuit protection **DO NOT** use a rewireable fuse. Instead use a suitably rated miniature circuit breaker (MCB) or Cartridge Fuse.

Do not turn on the electrical supply until the plumbing has been completed and the Mixing Valve cover re-fitted (if removed).

Installation - Mixing Valve

Fixing the Mixing Valve to the floor / wall

Please refer to Positioning the Mixing Valve on page 9 before starting any installation.

The Mixing Valve needs to be installed on either a flat floor or a wall surface.

Position the Mixing Valve on the floor or wall surface and mark all 4 fixing points.

⚠ Warning: Please check for any hidden pipes and cables before drilling holes into the floor / wall.

If you are fitting the Mixing Valve to a partition wall, a wall of particularly friable (crumbly) substrate or a wooden floor you will need appropriate fixings for the floor / wall type.

Drill suitable holes in the floor / wall surface at the marked positions and insert wall plugs (if required).

Secure the Mixing Valve to the floor/wall surface using the fixings supplied or suitable fixings dependant on floor / wall type.

⚠ Important: Under no circumstances should the mixing valve be recessed as this may prevent air circulating and condensation escaping.

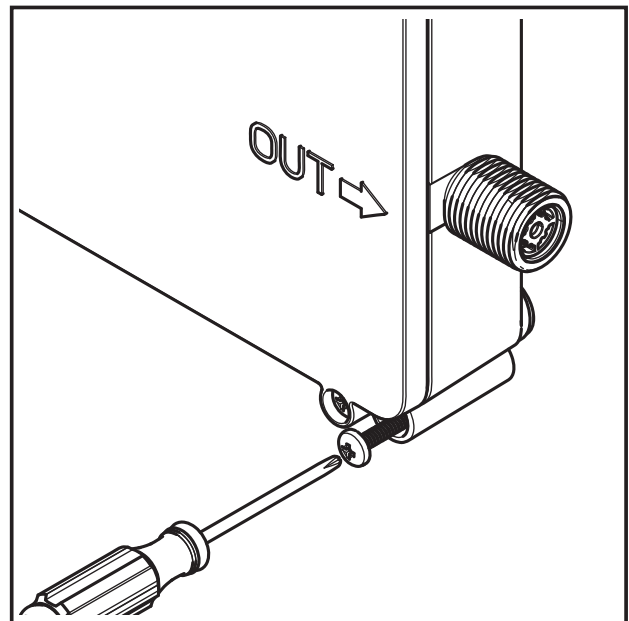
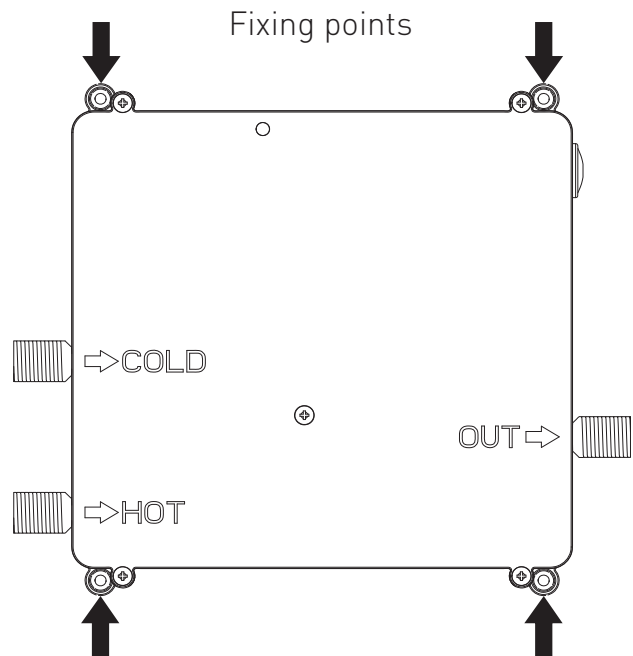

Installation - Water Connections

Plumbing Connections

⚠ Warning: Do not solder within 300mm of the Mixing Valve or allow solder or flux to fall onto the casing.

Important: An additional independent stop valve complying with the current water regulations must be fitted in the mains water supply as a means of isolating the supplies to the Mixing Valve for servicing and / or maintenance work.

It is essential that all pipe work is flushed through to remove debris and swarf that could otherwise damage the unit. Once the pipework has been flushed through, turn off the water supplies at the stop / service valves.

The supplied filter washers supplied **must** be fitted into both inlets.

The connecting pipework must present 1/2 BSP connectors to the male thread on the inlet connections.

See opposite for different pipework connection options.

Important: The pipework must run as straight as possible to the Mixing Valve minimising 90° angled bends as this could affect the inlet pressure to the Mixing Valve reducing performance.

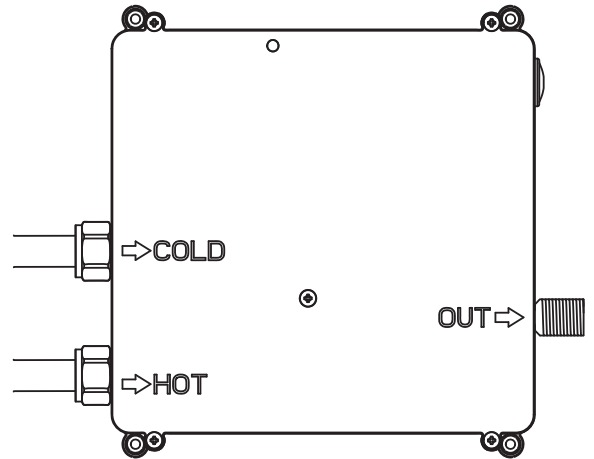

15mm Pipe work - 1/2" BSP connectors

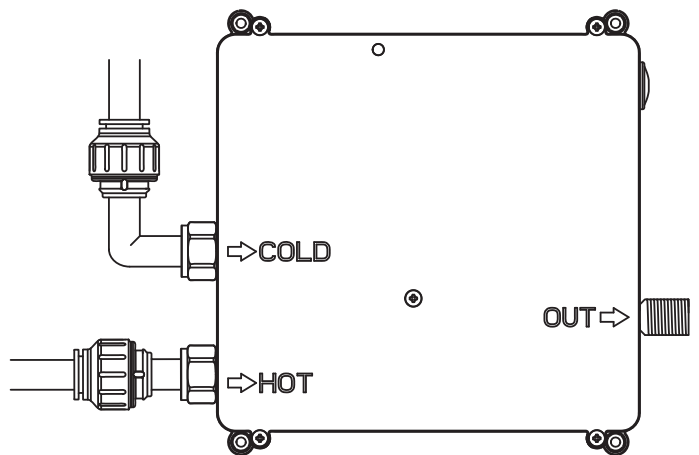

1/2" BSP Push-fit Connectors

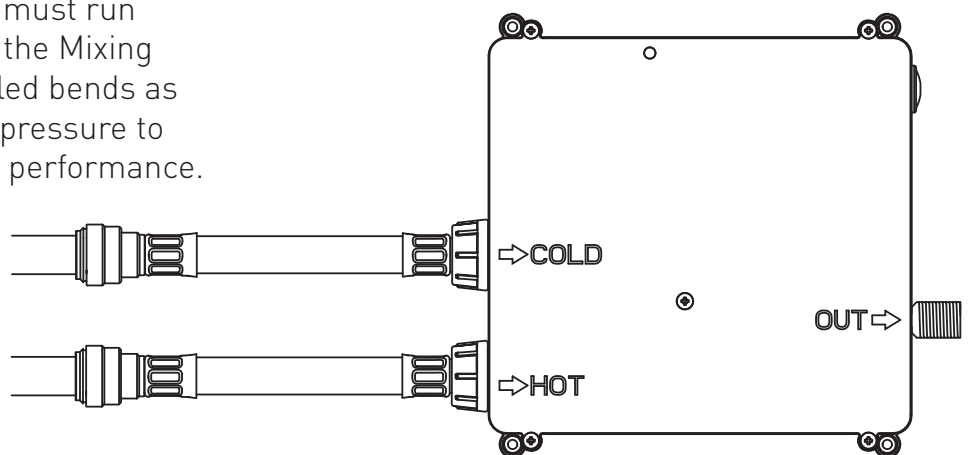

1/2" BSP Flexi Tails

Installation - Electrical Connections

Electrical Connections

The electrical installation must be carried out in accordance with the current I.E.E Wiring Regulations (BS 7671) and Building Regulations (Part P).

 **Warning:** This appliance and all connecting metal pipework must be earthed via the supply cord, which must be correctly connected to the earth point located in the terminal box.

The Mixing Valve must be permanently connected to the fixed wiring of the mains supply using the factory fitted supply cord, via a double pole switched fused spur off the ring main.

In the interests of electrical safety a 30mA residual current device (R.C.D. not supplied) should be installed in the supply circuit. This may be part of a consumer unit or a separate unit.

Wiring of connection unit:

 **Warning:** This appliance must be earthed.

The wires in the mains lead are coloured in accordance with the following code:

Green and Yellow	Earth
Blue	Neutral
Brown	Live

As the colours of the wires in the mains lead of this appliance may not correspond with the coloured markings identifying the terminals in your connection unit proceed as follows:

- The wire which is coloured green and yellow must be connected to the terminal in the connection unit which is marked with the letter E or by the earth symbol or coloured green or green and yellow.
- The wire which is coloured blue must be connected to the terminal which is marked with the letter N or coloured black.
- The wire which is coloured brown must be connected to the terminal which is marked with the letter L or coloured red.

Installation - Remote Control

Fitting the Wireless Controller

Remove the locking ring and wall bracket from the wireless controller by twisting the locking ring clockwise.

Position the wall bracket onto the finished wall surface and mark the fixing holes.

Drill holes at the marked positions on the wall surface using a suitable drill bit for the fixings.

Warning: Please check for any  hidden pipes and cables before drilling holes in the wall.

Tips:

A piece of insulation or masking tape positioned where holes are to be drilled and before marking out the exact position for the fixing holes will help stop the drill bit from wandering, particularly on a tiled surface.

When working near a basin, bath or shower insert plug or cover waste to prevent losing small parts.

Take care not to drop tools/equipment into basin, bath or shower during installation.

Secure the wall bracket to the wall using the fixings supplied or suitable fixings for the wall type, ensuring the locking ring is positioned behind the fixing bracket.

Once the wall bracket is secured to the wall surface turn the locking ring so that one of the four fixing lugs is at a 12 o'clock position.

Fit the remote control onto the locking ring. Twist the locking ring anti-clockwise to lock the remote control into position.

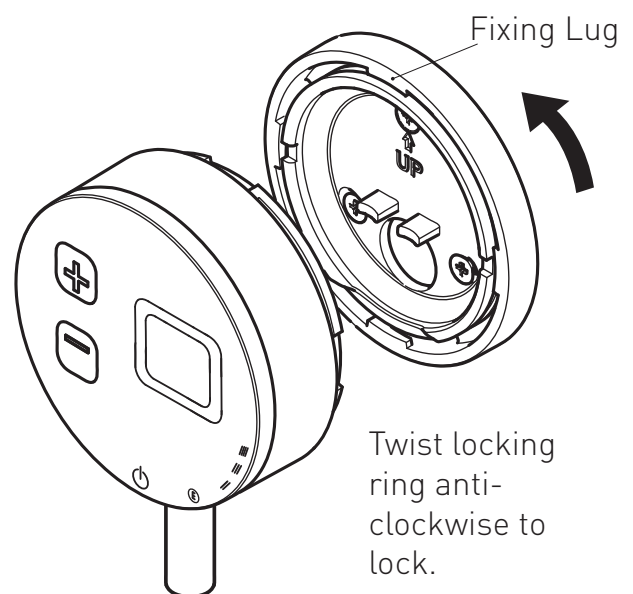
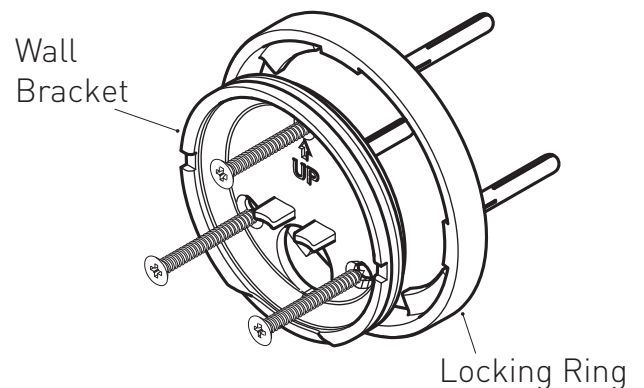
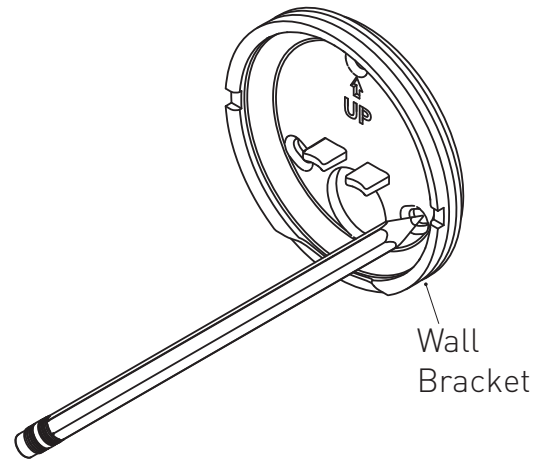

Installation

Fitting the Wall Outlet

There are two methods of fixing the wall outlet depending on the type of wall:

a: With rear access once wall finished

Screw the threaded connecting tube (2) into the wall outlet (5) ensuring the washer (3) is fitted in-between. Fit the rubber gasket (4) to the back of the wall outlet, place the assembly through a 25-30mm hole in the wall and secure with the backnut (1).

Connect the wall outlet assembly to the shower valve outlet using suitable pipework.

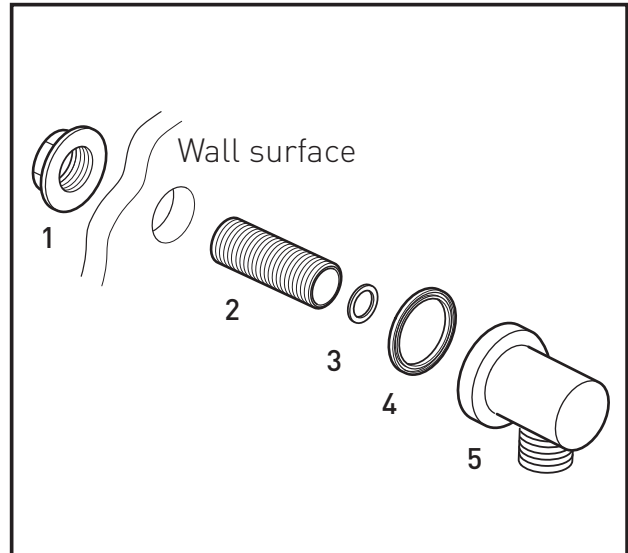

b: Without rear access once wall finished

Fit a 'wall plate elbow' (1) (not supplied) within the wall cavity and plumb in with suitable pipework from the shower valve. Screw the threaded connecting tube (2) into the 'wall plate elbow' using a suitable thread sealant. The threaded connecting tube thread must protrude from the finished wall by 5-15mm. Once the wall has been finished, the wall outlet (5), washer (3) and rubber gasket (4) can be fitted to the threaded connecting tube (using a suitable thread sealant).

Note: The backnut is not required with this method of fixing.

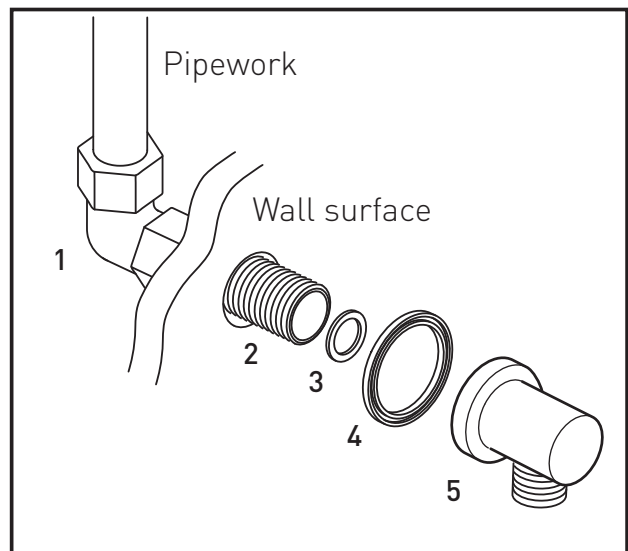

Installation - Riser Rail

Fitting the Riser Rail

Before proceeding with fitting the rail, identify each of the items supplied using the illustration on the right.

Slide the handset holder and hose retainer onto the bottom of the rail. Position a wall bracket onto each end of the rail, ensuring the large hole through the top of the rail lines up with the hole in the top wall bracket.

Note: The underside of the slider bracket has a button to release the slider and allows the height to be adjusted.

Position the rail on the wall, bearing in mind the different heights of people likely to use the shower and the length of the hose when connected to the wall outlet and passed through the hose retainer. Mark the wall to indicate the upper fixing screw position

Warning: Please check for any hidden pipes and cables before drilling holes in the wall.

Tips:

A piece of installation or masking tape positioned where holes are to be drilled and before marking out the exact position for the fixing holes will help stop the drill bit from wandering, particularly on a tiled surface.

When working near a basin, bath or shower insert plug or cover waste to prevent losing small parts.

Take care not to drop tools/equipment into basin, bath or shower during shower installation.

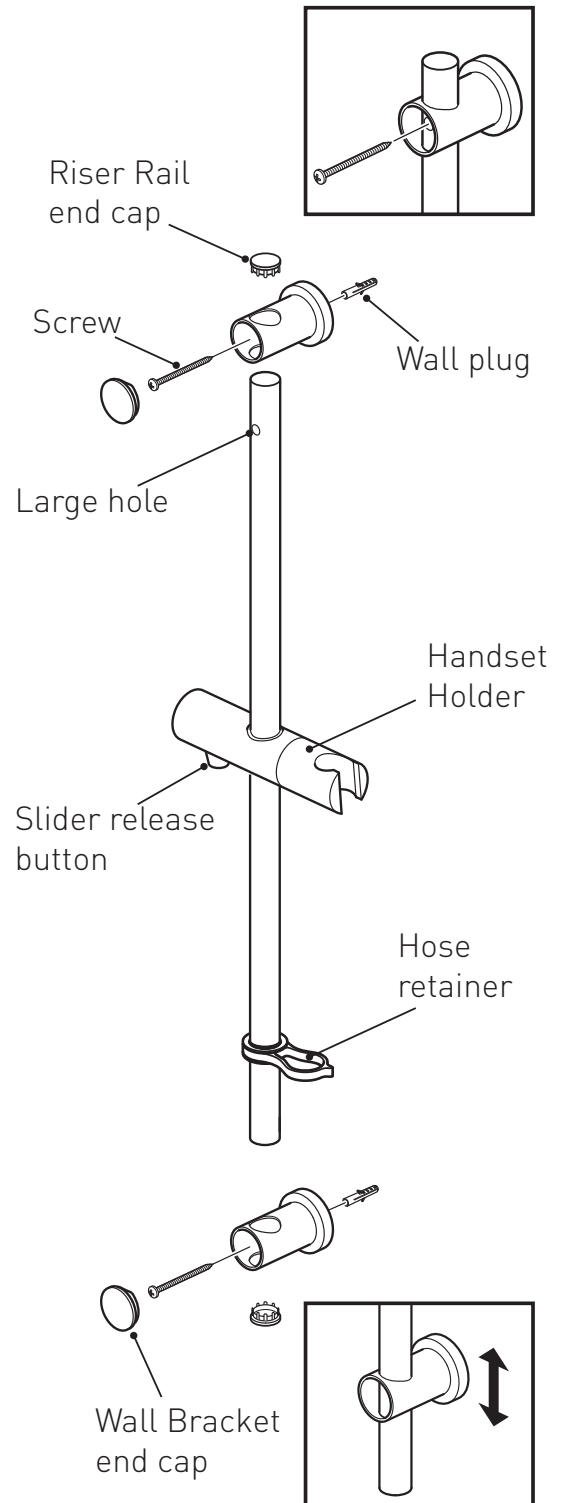

Installation - Riser Rail cont.

Drill the wall at the marked fixing position to suit the wall fixings supplied, loosely fix the rail (with the large hole at the top) and wall bracket. Check that the rail is hanging vertically using a spirit level.

Slide the lower wall bracket onto the rail and mark its required position onto the wall.

Note: The lower wall bracket does not fix to the riser tube and can be positioned along the riser tube so as to cover either an existing riser hole in the wall or over a tile joint.

Remove the lower bracket from the rail and unscrew the upper bracket from the wall. Mark and drill the lower wall bracket fixing position and fix the bracket to the wall. Slide the rail down through the lower wall bracket and reattach the upper bracket.

Check that the rail is perfectly vertical and tighten the upper fixing screw. Insert the wall bracket end caps into the wall brackets and the riser rail end caps at both ends of the rail.

When fitting the hose, it should pass through the hose retainer as shown opposite.

Note: The conical hose end and not the handset handle, fits into the slider bracket. Ensure the washer is fitted between the hose and the handset. The slider moves more freely on the rail if gripped next to the rail, rather than at the handset.

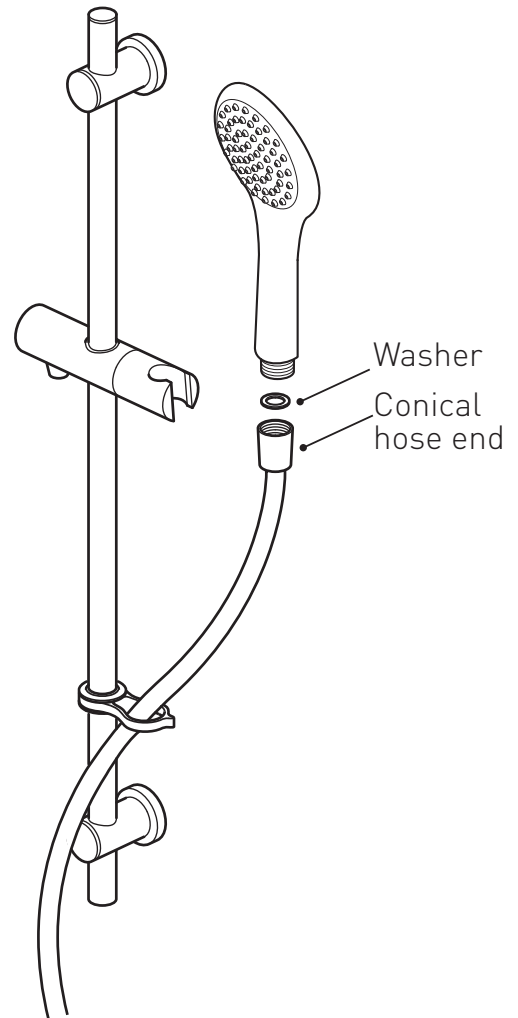

Commissioning - Wireless Connection

Wireless Initialisation & Pairing of the remote control to mixing valve



For the wireless communication to work, the Remote Control needs to be initialised and paired with the Mixing Valve. This is pre-configured upon manufacturing of the product, so the product should work "out-of-the-box".

1. Check the Wireless Communication is configured correctly.

Ensure the Remote Control is equipped with the 2 x AA batteries supplied and the flow lever is in the  position (6 o'clock).

Isolate both hot and cold water supplies to the Mixing Valve and turn the power to the Mixing Valve off.

1.1. Power on the Mixing Valve. The LED will initially show "Green". Wait for ~30 seconds, the LED will show "Yellow" to indicate "No wireless connection".

1.2. Turn the Remote Control "on" by turning the flow lever to "eco"  position (5 o'clock). The Mixing Valve LED should return to "Green" in a few seconds to indicate wireless communication. Turn the Remote Control "off" by turning the lever back to  and turn the power off to the Mixing Valve.

If the Mixing Valve LED returns to "Green", the product is Initialised and Paired correctly and no further action is required.

If the Mixing Valve LED stays "Yellow", the Wireless Connection is not configured correctly. Proceed with the Initialise (2) and Pairing (3) steps.

Additionally, it may also be necessary to perform the Initialisation and Pairing (Steps 2 & 3), if:

- You purchase a separate / replacement unit (either the Mixing Valve or Remote Control).
- The pre-set address used for the Pairing is used on a second nearby Wireless Controller.



IMPORTANT: Both the Initialisation and Pairing steps must be performed in sequence.

2. Initialise the Remote Control Wireless Address.



2.1. Turn the Remote Control "on" by turning the lever to the "eco"  position.

a. If the display shows a flashing 2-digit number, e.g. "30". Proceed to step (2.2).

b. If the display shows a single flashing "0", press the Temp up  button ten times to increment the flashing number from "0" to "9", and then to a flashing 2-digit number, e.g. "30". This has now Initialised the Remote Control - proceed to Pairing (3).



2.2. Enter Engineering Mode: press and hold both the Temp up  and Temp down  buttons together for more than three seconds, then release.

Note: If "2" is displayed, press Temp down  button twice to read "0".

2.3. Press the Temp up  or Temp down  button to change the number until "2" is displayed, The "2" will stay displayed for ~2 seconds, and then change to a flashing "0".

Commissioning - Max Temp Setting



2.4. Press the Temp up  button ten times to increment the flashing number from “0” to “9”, and then to steady-state “2” or ‘E1’. This has now Initialised the remote control.

2.5. Exit Engineering Mode: Press the Temp down  button twice to change the displayed number back to “0”, and / or turn the Remote Control “off” by turning the lever back to .

3. Pairing the Remote Control to the Mixing Valve.

3.1. Remove the cover from the Mixing Valve and locate the switches marked SW1 on the circuit board. Set switch 4 to ‘ON’ and loosely replace the cover.

3.2. Power up the Mixing Valve. Wait ~30 seconds for the LED to show “Yellow”.

3.3. Turn the remote control “on” by turning the lever to the eco  position. Wait for the Mixing Valve LED to show “Green” (this should only take a couple of seconds). Turn the Remote Control “off” by turning the lever back to the “off”  position.

3.4. Power down the Mixing Valve. Remove the cover from the Mixing Valve, set switch 4 at SW1 to “off” and replace the cover. The Mixing Valve and Remote Control are now Paired.

Maximum Temperature Setting

The maximum temperature is factory pre-set to 48°C. To change the maximum outlet water temperature follow the steps below.

1. Power down the Mixing Valve and remove the front cover.

2. Locate the four switches marked SW1

on the circuit board. Position the switches as per the following diagrams.

Note: Only switches 1-3 need to be altered.

38°C

SW1-1 OFF
SW1-2 OFF
SW1-3 OFF

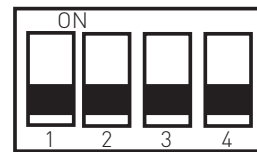

41°C

SW1-1 ON
SW1-2 OFF
SW1-3 OFF

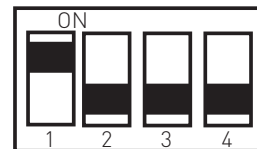

44°C

SW1-1 OFF
SW1-2 ON
SW1-3 OFF

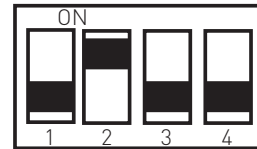

46°C

SW1-1 ON
SW1-2 ON
SW1-3 OFF

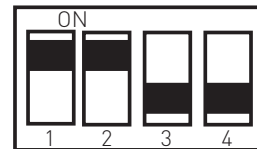

48°C

SW1-1 OFF
SW1-2 OFF
SW1-3 ON

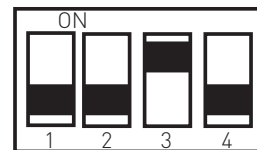

Once the switches have been altered, to the desired position the maximum temperature is set.

3. Replace the Mixing Valve cover and secure with the four fixing screws.

IMPORTANT: It is important to power down the Mixing Valve to change the switch settings as they are only read on power up.

Commissioning - Functional Testing

Checking Water / Plumbing Connections

Before using the shower for the first time the installer needs to check that the water/plumbing connections are correct.

The cold water supply pipework should only be connected to the top inlet (marked COLD on the Mixing Valve cover).

The hot water supply pipework should only be connected to the bottom inlet (marked HOT on the Mixing Valve cover).

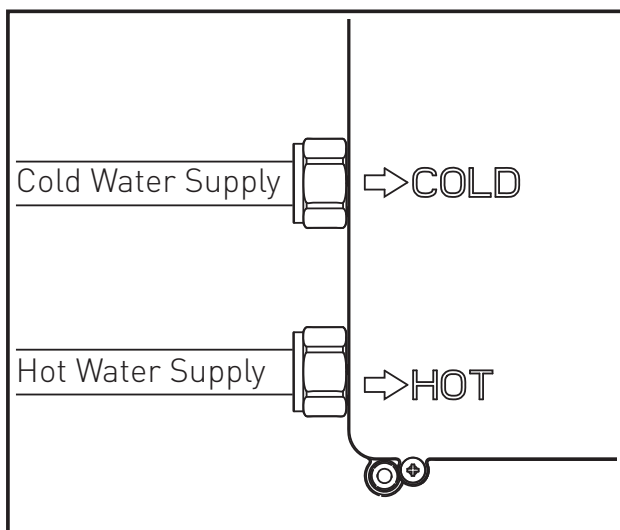

Turn on the water supplies to the Mixing Valve and open the stop / service valves to the mixing valve.

Check that there are no leaks around the connections to the inlets and outlet.

Basic functional Testing

Prior to using the shower the following tests should be carried out to ensure the Mixing Valve is working correctly.

Power on the Mixing Valve. Check the display on the Remote Control is working.

Check flow control. Operate the lever to all flow positions and check for increased flow.

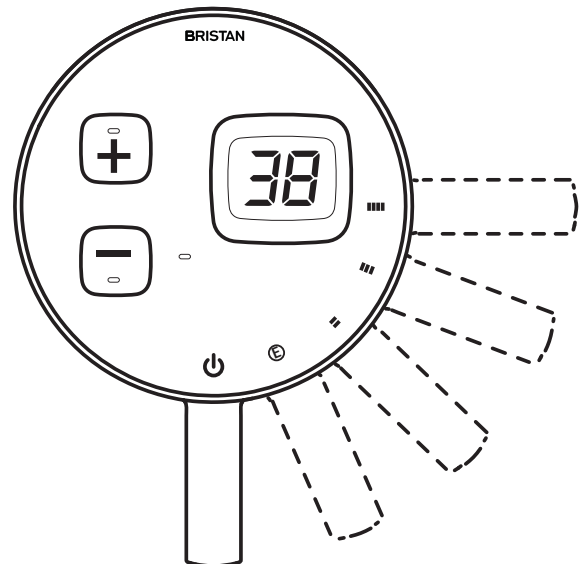

Check Temperature controls. Press the  and  temperature buttons to check that that the temperature increases and decreases.

Check digital display. Ensure the temperature display increases and decrease when pressing the temperature controls.

Operating the Shower

Please ensure the commissioning procedure has been carried out. If you did not fit this shower yourself and you are about to use it for the first time, check with the installer to ensure they have run the commissioning procedure as described on pages 19-21.

To Start the Shower

Turn the lever (1) anti-clockwise.

To Stop the Shower







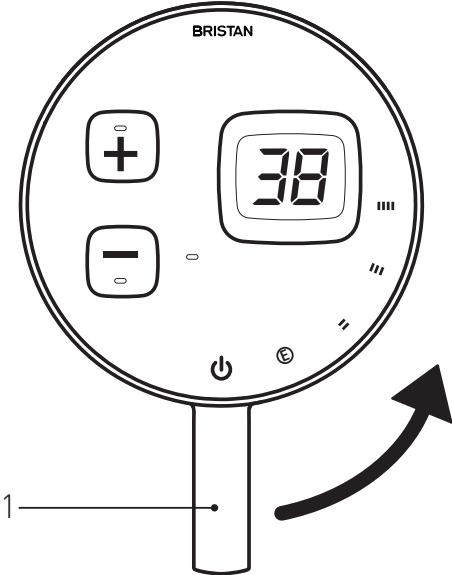

Turn the lever (1) clockwise back to .

 **Warning:** This appliance is not intended for use by persons (including children) with reduced physical, sensory or mental capabilities, or lack of experience and knowledge, unless they have been given supervision or instruction concerning use of the appliance by a person responsible for their safety.

Important: Children should be supervised to ensure that they do not play with the appliance.



Operating the controls

	Temperature Control	
		→  Hot
		→  Cold
		Low Battery Warning Light
Flow Control		
	→ Eco Water Saving Mode	
	→ Low Flow	
	→ Medium Flow	
	→ High Flow	

Maintenance

General Cleaning

Your fitting has a high quality finish and should be treated with care to preserve the visible surfaces. All surfaces will wear if not cleaned correctly, the only safe way to clean your product is to wipe with a soft damp cloth. Stains can be removed using washing up liquid. All bath cleaning powders and liquids will damage the surface of your fitting, even the non-scratch cleaners.

Note: Never use abrasive detergents or disinfectants or those containing alcohol, hydrochloric acid or phosphoric acid.



Bristan recommend E-cloth for cleaning all of our bathroom & kitchen products. Using just water, E-cloth gives a smear

free, deep clean by breaking up and holding dirt, which normal cloths leave behind. Order through your Bristan stockist (order code: ECLOTH).

Cleaning the Showerhead

Your Bristan showerhead has rub-clean nozzles for easy cleaning. Simply rub your fingers across the rubber spray jets regularly and before you turn the shower on to remove any scale or debris. The hardness of the water in your area will determine how often you should clean your showerhead. Build up of scale in particularly hard water areas combined with constant use means you may need to clean your showerhead once a week. To ensure continued performance of your shower the showerhead needs to be regularly descaled.

NRV & Filter Maintenance

The Mixing Valve is supplied with a Non-Return Valve fitted into each inlet. The filter washers which seal the inlet and connection may become scaled over in particularly hard water areas and may need cleaning on a regular basis to ensure maximum performance.

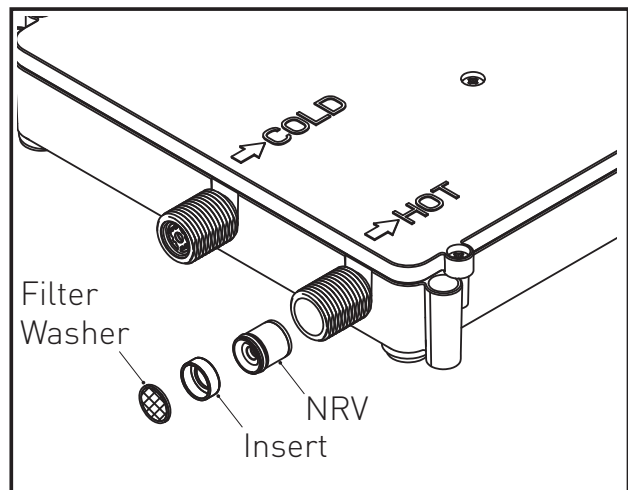

Cleaning the Filters

Isolate both hot and cold water supplies to the Mixing Valve and remove the connections from the inlets. Run both filter washers under running water and rub your fingers over the mesh to remove any build up of scale.

Replacing the NRVs

Isolate both hot and cold water supplies to the Mixing Valve and remove the inlet connections. Remove the filter washers and inserts from the inlets. Carefully prise out the NRVs from the inlets using a small thin bladed tool i.e. flat head screw driver. Insert new NRVs back into the inlets and replace the inserts and filter washers.

Re-fit the inlet connections ensuring they are fully tightened.

Maintenance

Battery Replacement

The Wireless Controller is powered by two AA batteries which are designed to last approximately 1 year based on average showering usage before they need replacing.

When the batteries run low and require replacing, the red low battery LED on the front face of the display will flash.

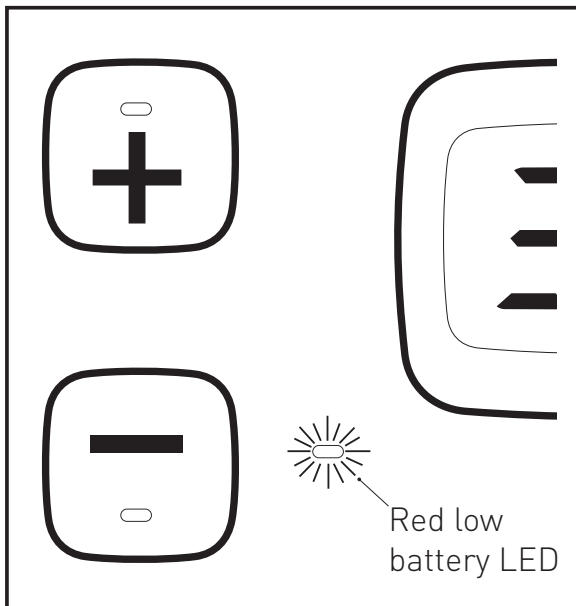

To replace the batteries the following should be carried out;

Remove the Wireless Controller from the fall bracket by twisting the locking ring clockwise to unlock the Wireless Controller from the backplate.

Remove the old batteries and replace with new AA batteries.

Note: Batteries must be 1.5V AA (LR6) Alkaline batteries (preferably =>2000mAh for good battery life).

Important: Do not use re-chargeable batteries.

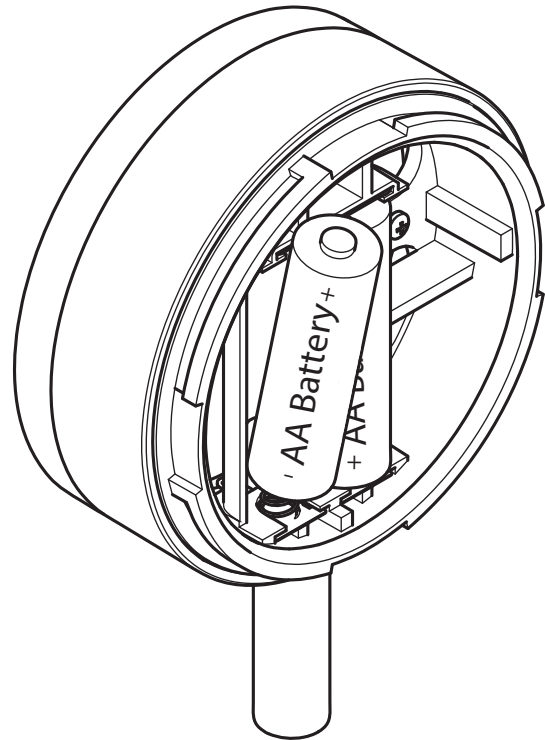

Important: Incorrect insertion of the batteries may damage the batteries.

Re-attach the Wireless Controller onto the locking ring once the new batteries have been inserted. Twist the locking ring anti-clockwise to lock the Remote Control in position.

Maintenance

Disposal and Recycling

End of Product Life

When this appliance has reached the end of its serviceable life, it should be disposed of in a safe manner, in accordance with current local authority recycling, or waste disposal policy.

Battery disposal

Spent batteries should not be disposed of with normal household waste. Contact your local authority for information on waste disposal and recycling.

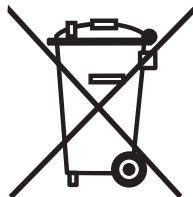

This symbol on the product or packaging indicates that this product should not be disposed of with your other household waste. Instead, it is your responsibility to dispose of your waste equipment by handing it over to a designated collection point for the recycling of waste electrical and electronic equipment. The separate collection and recycling of your waste equipment at the time of disposal will help to conserve natural resources and ensure that it is recycled in a manner that protects human

health and the environment. For more information about where you can drop off your waste equipment for recycling, please contact your local council office, your household waste disposal service or the shop where you purchased the product.

Troubleshooting

Symptom	Cause	Remedy
E1 displayed	Main unit is powered off.	Check power is on at the main unit and check if the LED is Green or Yellow, refer to Wireless Initialisation & Pairing of the Wireless Controller to the Mixing Valve in Commissioning Section (pages 19-21).
E2 displayed	Main unit has developed a fault.	Call Bristan Customer Services on 0844 701 6273.
E3 displayed	Hot water is isolated or has insufficient flow.	Check the hot water supply is not isolated.
	Inlet filter on the hot water supply is blocked.	Remove filter and clean, refer to maintenance section (pages 23-25).
	Hot water too hot.	Check hot water is functioning correctly, refer to specification (page 7).
	Hot water too cold.	Check hot water is functioning correctly, refer to specification (page 7).
E4 displayed	Cold water is isolated or has insufficient flow.	Check the cold water supply is not isolated.
	Inlet filter on the cold water supply is blocked.	Remove filter and clean, refer to maintenance section (pages 23-25).
	Cold water too hot.	Check cold water is functioning correctly, refer to specification (page 7).
	Cold water too cold.	Check cold water is functioning correctly, refer to specification (page 7).

Troubleshooting

Symptom	Cause	Remedy
No or low water flow	Batteries low / run out in Wireless Controller.	Replace batteries, refer to maintenance section (pages 23-25).
	Outlet is blocked.	Check outlet hose and showerhead for any blockages.
	Partially closed stop or service valve in water supply pipework to the mixing valve.	Open stop or service valve.
	Airlock or potential blockage in supply pipework.	Flush through pipework to ensure removal of any debris and any airlocks.
	Inlet filters partially blocked.	Remove filters and clean as necessary, refer to maintenance section (pages 23-25).
	Water supply pressure too low.	Check water pressure, refer to Specification section (page 7).
Water leaking from the showerhead	This is normal for a short time after turning off.	Adjust the angle of the showerhead as necessary to vary draining time.
Maximum water temperature too hot or cold	Maximum water temperature set incorrectly.	Reset maximum water temperature, refer to Commissioning section (pages 19-21).

Spare Parts

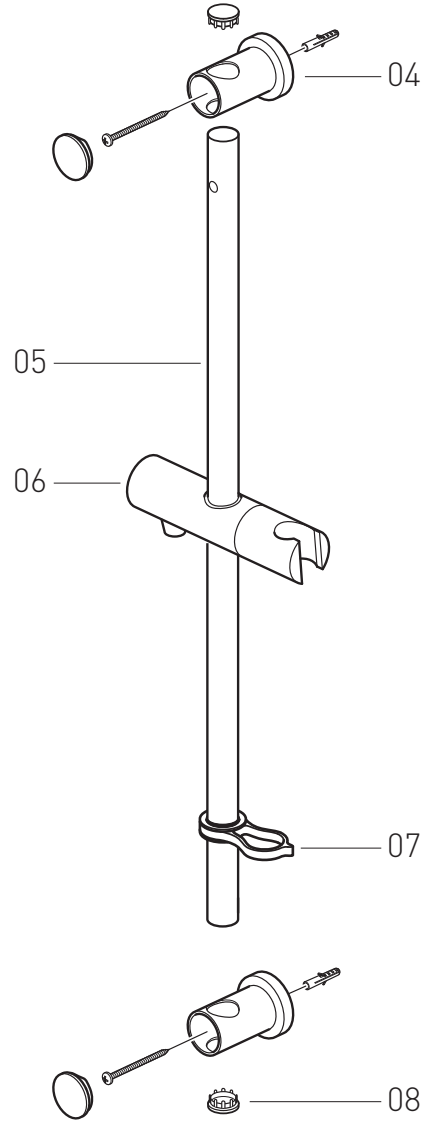
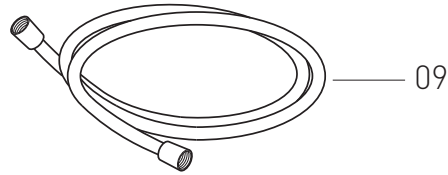
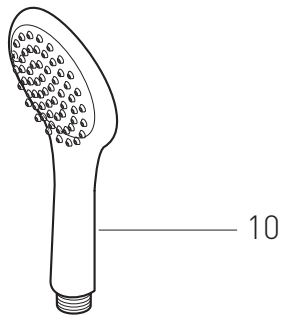
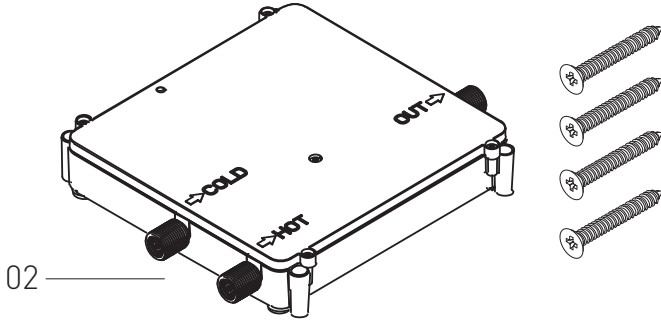
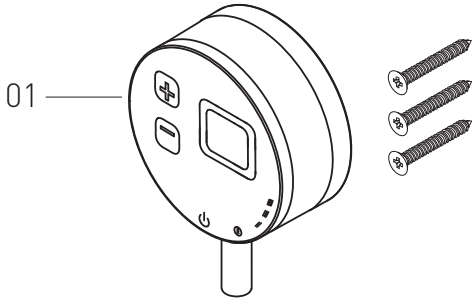

Spare Parts

No.	Part No.	Description	Parts List	Quantity
01	ARDE WC W	Controller (White) incl. fixings	White Controller x1 , Fixings x4	1
01	ARDE WC B	Controller (Black) incl. fixings	Black Controller x1 , Fixings x4	1
02	EMV WSO	Mixing Valve incl. fixings	Mixing Valve x1 , Fixings x4	1
03	NRV 08400A	NRV	NRV x1	1
04	11043AJA	Wall Bracket Ass.	Wall Brackets x2 , Wall Bracket End Caps x2 , Screws x2 , Wall plugs x2	2
05	207041-012C	Riser Rail Ass.	Riser Rail x1 , Riser Rail End Caps x2	1
06	1625AJA	Handset Holder	Handset x1	1
07	11044AOA	Hose Retainer	Hose Retainer x1	1
08	1408A0A	Riser Rail End Caps	Riser Rail End Caps x2	1
09	HOS 150CC02 C	Shower Hose	Hose x1 , Rubber Washers x2	1
10	S81011	Handset	Handset x1	1

Guarantee

At Bristan, we want to make things as easy as possible for our customers. That's why we design products that are easy to fit and use, and that are quality tested to make sure they won't let you down. It's also why we offer solid guarantees on all products, effective from the date of purchase, to give you peace of mind.

Bristan's Digital Electronic Mixer Valve is covered by a **5 year guarantee**. This also includes **1 year labour cover** * which means that, in the unlikely event that there is a problem in the first year after purchase, we'll send one of our expert engineers to fix it.

*Labour is provided by an approved Bristan Care engineer or appointed representative. The guarantee only applies to products with a manufacturing fault. There will be a call out charge for any incidents where no fault has been found with the product, or if the issue is due to poor installation or maintenance.

Guarantee Terms and Conditions

This guarantee is in addition to your statutory and other legal rights and is subject to the following conditions:

- The product was purchased within the United Kingdom or Republic of Ireland.
- The guarantee applies solely to the original purchaser with proof of purchase.
- The installation must allow ready access to all products for the purpose of inspection, maintenance or replacement.

- Repair under this guarantee does not extend the original expiry date. The guarantee on any replacement parts or product ends at the original expiry date.
- Any part found to be defective during the guarantee period will be replaced without charge, providing that the product has been installed in accordance with the instructions given in this guide and used as the manufacturer intended.

The guarantee does not cover:

- Damage or defects caused by;
 - General wear and tear (including special non-chrome finishes; components such as filters, seals, 'O' rings and washers)
 - Incorrect installation
 - Repair using non-Bristan parts
 - Accidental or wilful misuse
 - Corrosion and the use of inappropriate cleaning products
 - System debris including the build up of limescale (which can be controlled through regular servicing and maintenance)
- Compensation for loss of use of the product or consequential loss of any kind.

In the interests of continuous product improvement, Bristan reserves the right to alter product specifications without notice.

The Bristan Product Guarantee does not affect your statutory rights as a consumer.

Guarantee

• Need help?

If this product does not function correctly when first used, contact **Bristan Care Customer Service on 0844 701 6273** where our expert team of advisors will be able to offer you help and advice.

• Problems during the guarantee period

In the unlikely event that you encounter any problems with the product during the guarantee period, contact **Bristan Care Customer Service on 0844 701 6273** with your proof of purchase and we will work to resolve the problem quickly.

Bristan Care Customer Support

Bristan customers also benefit from the support of Bristan Care, our comprehensive customer support package which offers:

Technical support hotline

(Tel: 0844 701 6273) with access to fully trained advisers who can offer installation advice, talk you through quick maintenance checks, or recommend the best course of action to fix any problems with a product.

Expert advice

Find easy to follow 'how to' video guides and technical FAQs online at www.bristan.com. Our guides take you step-by-step through many product installations and you can find plenty of easy guides to quick product fixes and servicing.

Spare parts

We hold thousands of spares and we keep them for discontinued products for over seven years. Spares can easily be ordered online at www.bristan.com and are dispatched the same day.

Expert plumbing engineers

If we can't solve the problem over the 'phone or with a spare part, then we'll send out one of our Bristan Care engineers to take a look. Bristan Care engineers provide free support for products that are within guarantee, but are also available to service products that are out of guarantee for a small charge. For details, please call **Bristan Care Customer Service on 0844 701 6273**.

Part Number: FI: ARDE SHCAR
Issue: D1

BRISTAN

Bristan Group Ltd,
Birch Coppice Business Park
Dordon
Tamworth
Staffordshire
B78 1SG
Web: www.bristan.com
Email: enquire@bristan.com

A Masco Company

Useful contact details:

Customer Service:

0844 7016273

Customer Service Email:

Customercare@bristan.com

Customer Service Fax:

0844 7016275

Reception:

0844 7016274

Join us on...

