

AQUALISA

Axis[®]

Digital

Exposed standard and pumped



The Waste Electrical and Electronic Equipment (Producer Responsibility) Regulation 2004

This product is outside the scope of the European Waste Electrical and Electronic Equipment Directive as interpreted within the UK.

In the UK this product can therefore be disposed of through commercial non-WEEE waste facilities.

The original manufacturer does not accept any liability under the WEEE directive.

Shower systems



Axis Digital exposed standard
AX8410



Axis Digital exposed pumped
AX8415

Components

Standard



Pumped



Important information

Safety information

This product must be installed by a competent person in accordance with all relevant Water and Wiring Supply Regulations. Electrical supply and bonding of the bathroom must comply with the current IEE regulations, and your attention is drawn to the requirements concerning protective earth bonding.

The water circuit should be installed so that other taps or appliances operated elsewhere within the premises do not significantly affect the flow.

This shower must not be used with a hot water supply temperature of over 65°C.

The Digital processor must not be installed in situations where the ambient temperature is likely to exceed 40°C.

The control must not be installed in situations where the ambient temperature is likely to fall below 5°C or rise above 70°C.

We do not recommend the use of Axis Digital in steam therapy facilities.

This appliance must be earthed.

Cables which are chased into the wall must be protected by the use of conduit or sheathing.

Surface mounted cables must also be protected by a suitable approved conduit.

The power lead must only be replaced by the manufacturer or his accredited service agent.

The user control is supplied from a safety extra low voltage source.

This product is suitable for household use only.

SPECIAL NOTES FOR INSTALLATION OF DIGITAL PUMPED PROCESSOR

- 1) The Axis Digital pumped shower system is designed to operate up to a maximum static pressure of 1 bar (14.5 psi).
- 2) Under no circumstances must the pumped processor be connected directly to the water main or in line with another booster pump.
- 3) The minimum actual capacity of the cold water storage cistern should be not less than 225 litres (50 gallons). The capacity of the hot water cylinder must be capable of meeting the anticipated demand.

SPECIAL NOTES FOR INSTALLATION OF DIGITAL STANDARD PROCESSOR

Pressures: The Axis Digital shower system is designed to operate up to a maximum static pressure of 7 bar (100psi). Where pressures are likely to exceed 7 bar (100psi), a pressure reducing valve must be fitted to the incoming mains supply. A setting of 4 bar (60psi) is recommended. It should be noted that daytime pressures approaching 6 bar (80psi) can rise above the stated maximum overnight.

COMBINATION BOILER SYSTEMS:

The appliance must have a minimum domestic hot water rating of 80,000 BTU (23.4kW) and be of the type fitted with a fully modulating gas valve.

The flow switch on the combi boiler needs to flow a minimum of 3 litres per minute. If in any doubt please contact the appliance manufacturer before installation commences.

**PLEASE NOTE: INLET TEMPERATURE CHANGE MAY CAUSE THE DIGITAL CONTROLLER TO FLASH.
THIS IS NOT NECESSARILY CHANGING THE OUTLET TEMPERATURE.**

Connections

This product incorporates 'push-fit' type connections. Tube should be cut using a rotary type cutter and lubricated using a silicone-based lubricant or petroleum jelly (Vaseline or similar) prior to insertion into the fitting.

THESE FITTINGS ARE NOT SUITABLE FOR STAINLESS STEEL TUBE.

Flushing

Some modern fluxes can be extremely corrosive and, if left in contact, will attack the working parts of this unit. All soldering must be completed and the pipework thoroughly flushed out in accordance with Water Supply Regulations prior to connection of the product.

After installation

Run through the system operation with the purchaser and hand them this guide. Complete and post the Axis guarantee card.

Step-by-step instructions

!

In addition to the guide below it is essential that the written instructions overleaf are read and understood and that you have all the necessary components (shown overleaf) before commencing installation.

!

The Axis Digital shower system is supplied with masonry fixings intended for use with a wall of solid construction. If the unit is to be installed on a wall of a different construction then please use alternative fixings as required.

1

The Axis Digital processor must be fixed in one of the three orientations shown.



2

Isolation valves are supplied with the Digital processor and must be fitted on both inlets and the mixed water outlet. For optimum performance, all inlet pipe work should be 15mm copper pipe. If plastic pipe is used, there will be a restriction in flow rate and performance. All pipe work should be supported.



!

For externally pumped gravity fed installations, 22mm pipe work should be run as close to the processor as possible before reducing down to 15mm.

3

Choose the position for your Digital processor as close to the shower control as possible. The processor may be sited in the roof space above the proposed shower site, in the airing cupboard or behind a screwed bath panel if more convenient. If siting in the roof space, ensure that freezing cannot occur and that no insulation material is placed under or over the processor. Please refer to the system layout diagrams opposite.



!

The optimum position for the Digital processor is in the roof space above the shower site to take full advantage of the ease and speed of installation.



The distance between the Digital processor and shower control must be within range of the data cable supplied (7m). A 10m cable is available on request.



The processor must be sited in a position so that access can be gained for testing and service purposes.



Check valves are supplied with the non-pumped processor and should be fitted when used on combination boiler systems.

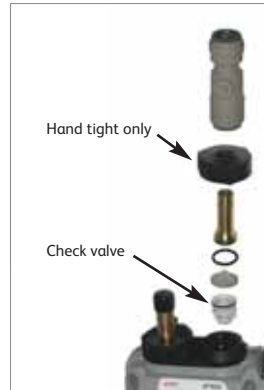

4

Place the Digital processor on a solid mounting surface, mark then drill and prepare suitable fixings before securing the processor to the mounting surface using the screws supplied in screw pack no. 1 (if suitable).



5

Flush through both the 15mm copper hot and cold supply pipes.



The maximum hot water inlet temperature must be no more than 65°C

6

Attach the supply pipes to the Digital processor, ensuring that the cold and hot feeds go into the appropriately marked inlets.



DO NOT SOLDER NEAR TO PLASTIC COMPONENTS

7

Locate a suitable entry spot in the ceiling for the riser rail, avoiding joists and services.

!

The centre of the riser rail stands 45mm from the wall. If this position interferes with either a joist or service then the use of a flexible hose is recommended which can later be hidden by an additional part available from Aqualisa.

8

Drill a hole through the ceiling minimum $\varnothing 30\text{mm}$, maximum $\varnothing 40\text{mm}$.

9

Mount the template to the wall in the required position ensuring vertical alignment using a spirit level to facilitate if necessary. Carefully mark the four fixing holes. Check the position of the Axis Digital unit before removing the template, then drill and prepare suitable wall fixings for the four mounting screws.

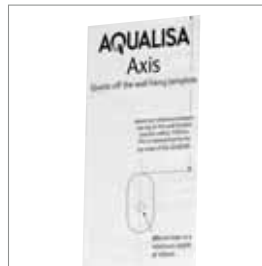

!

The maximum distance from the top fixing to the ceiling is detailed on the template. If there is coving or an alternative obstruction then this distance must still be accounted for otherwise the copper pipe could be visible within the showering area.

10

Fix the top wall bracket to the appropriate position using the screw provided in screw pack no. 2 (if suitable) ensuring that the arrow on the bracket is facing upwards.



11

Secure the mounting bracket using three of the screws supplied in screw pack no. 2 (if suitable) ensuring that the bracket is mounted in the correct orientation as shown.



12

Before mounting the rail assembly to the wall ensure that both the hose restraint and the handset holder are below the position of the top wall bracket. Offer the assembly up to the top wall bracket and hook it onto the lip before clipping the control end of the rail onto the bottom mounting bracket.



13

To finally secure the control, tighten the captive screw at the base of the control using a small Posidrive screwdriver.



14

Connect the 15mm copper pipe to the mixed water outlet on the Digital processor. Using pipe clips as appropriate, ensure that all pipe work is perpendicular to the processor, i.e. not putting any strain on the fittings.

!

Do not solder any additional pipe work to the 15mm copper pipe from the Digital shower system as the low voltage data cable could be damaged. Instead use push-fit fittings if necessary to connect additional copper piping.

TO ENSURE OPTIMUM PERFORMANCE USE THE MINIMUM AMOUNT OF ELBOWS

15

Connect the low voltage data cable to the Digital processor via the socket located under the black protective flap. Feed the cable out of the processor by threading it under the small red lip to the left of the socket, then screw the flap back down to provide a watertight seal.



16

Connect the power lead to a 3 amp fused switched spur. Ensure that this is in an accessible location and not in the bathroom. The fused spur must provide a contact separation of at least 3mm from the supply in all poles (Live and Neutral).



THIS APPLIANCE MUST BE EARTHED

The data cable and power lead can be routed in the grooves provided under the processor. They should also be clipped in place with 'P' clips or similar to avoid accidents.

17

Attach the shower hose only and flush through the system for 15 seconds to clear any debris before fitting the shower head. Thread the shower hose through the hose restraint before attaching the head and fitting it to the handset holder.



Please ensure that both hose washers (supplied in screw pack no. 3) are fitted at either end of the hose.

User Guide



Control

1. Turn the temperature dial to the required setting.



2. Press the 'start' button on the control.

3. The red and blue LED display will flash until the selected temperature has been reached.

4. When the LED display is constant, step into your shower and enjoy!

5. The temperature may be adjusted once in the shower.



Pumped shower only: Press the 'boost' button on the control to increase the strength of the power shower option when desired.



Adjustable height head

To select the preferred height for the shower head, depress the slider levers fully to enable the holder to be moved up or down the rail.



Angular adjustment is made by carefully but firmly pulling forwards or pushing back the shower head against the knuckle ratchet in the holder.

Cleaning

Your Digital shower system should be cleaned using only a soft cloth and washing-up liquid.

DO NOT USE ABRASIVE CLEANERS

To reduce the need for chemical descaling in hard water areas, your shower head incorporates a 'clear flow' system whereby any scale build up can be broken down by gently rubbing the flexible tips of the jets during use.

Should chemical descaling of the head ever become necessary, simply unscrew the spray cassette and soak it in a mild proprietary descaler.

Typical installations

Typical gravity system installation

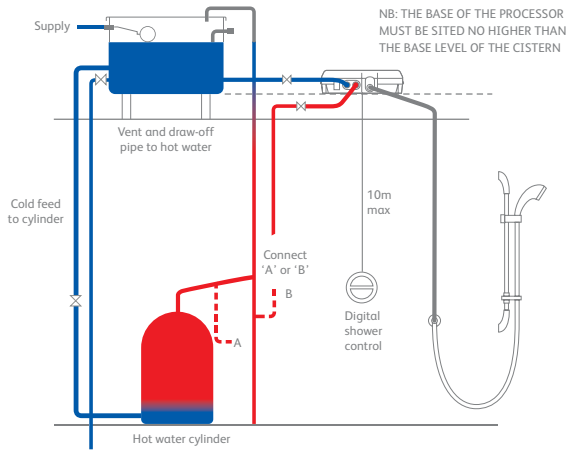

Typical Thermal storage unit system installation

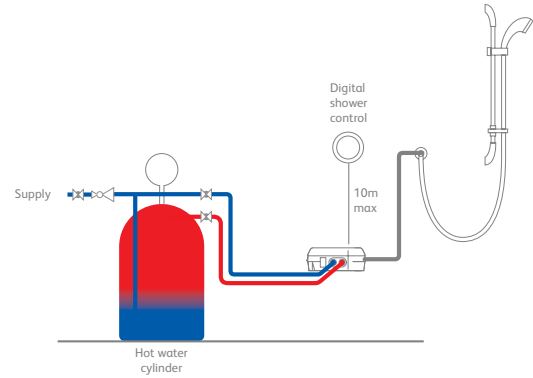

Typical pumped system installation

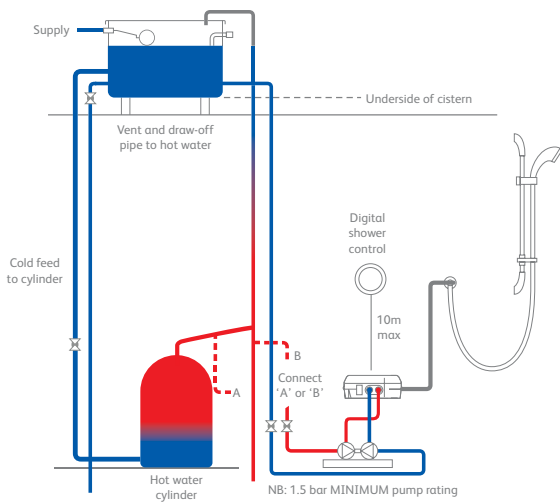

Typical UHW system installation

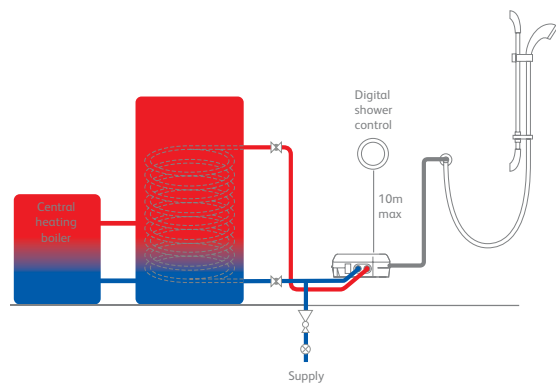

Typical combination boiler installation

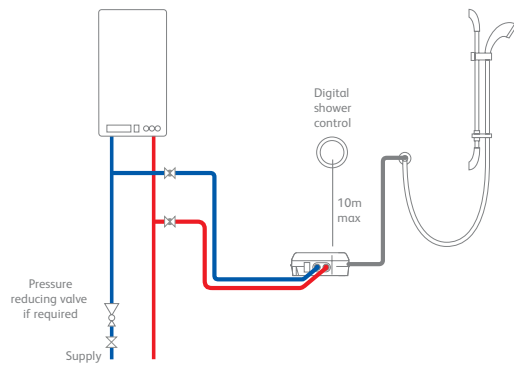



AQUALISA

Aqualisa Products Limited
The Flyer's Way
Westerham Kent TN16 1DE

Sales enquiries: 01959 560010

Republic of Ireland 01-864-3363

Customer helpline: 01959 560010

Republic of Ireland 01-844-3212

Brochure Hotline: 0800 652 3669

Website: www.aqualisa.co.uk

Email: enquiries@aqualisa.co.uk



Please note that calls may be recorded for training and quality purposes

The company reserves the right to alter, change or modify the product specifications without prior warning

© Registered Trademark Aqualisa Products Limited